

## IT INDICE

1. FERRAMENTA .....	2
2. INSTALLAZIONE .....	3

## GB CONTENTS

1. HARDWARE KIT .....	2
2. INSTALLATION .....	3

## D INHALTSVERZEICHNIS

1. EISENWAREN-KIT .....	2
2. MONTAGE .....	3

## F INDEX

1. QUINCAILLERIE .....	2
2. INSTALLATION .....	3

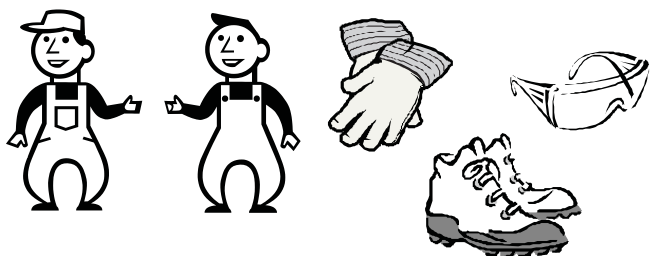

IT **ATTENZIONE:**  
VERIFICARE LA BOLLA

GB **ATTENTION:**  
VERIFY THE FLATNESS

D **ACHTUNG:**  
DIE WAAGERECHTIGKEIT KONTROLLIEREN

F **ATTENTION:**  
VÉRIFIER LE FIL À PLOMB

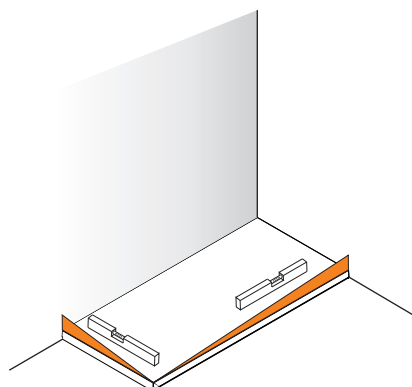
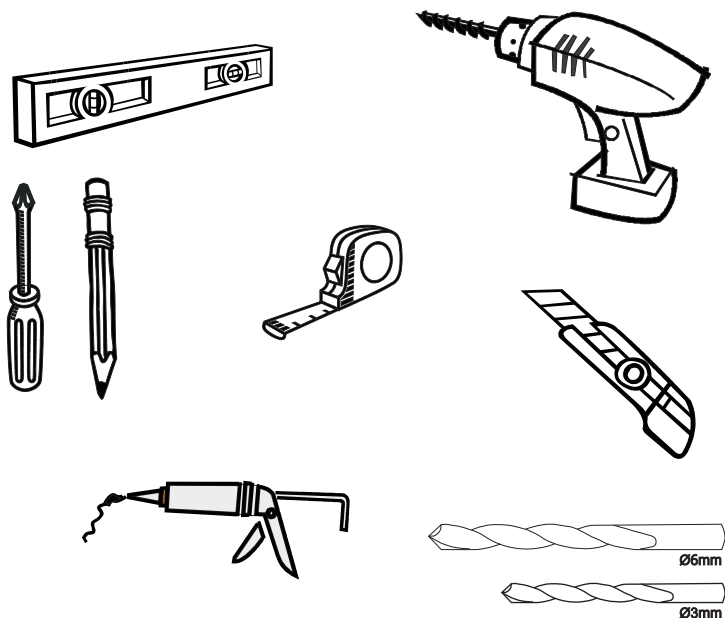

IT

1. FERRAMENTA

GB

1. HARDWARE KIT

D

1.EISENWAREN-KIT

F

1. QUINCAILLERIE

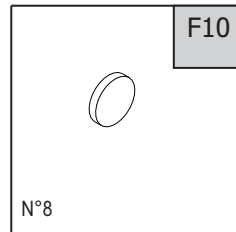
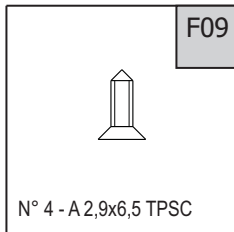
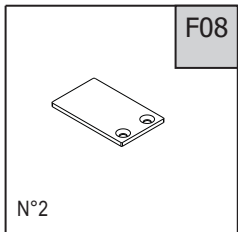
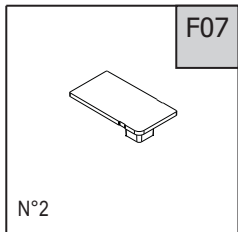
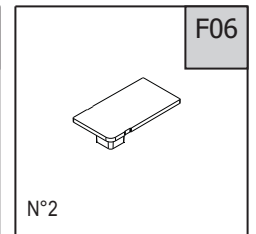
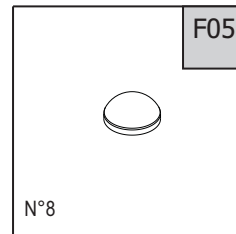
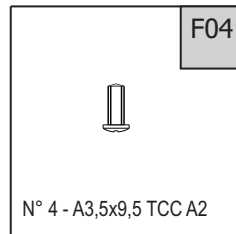
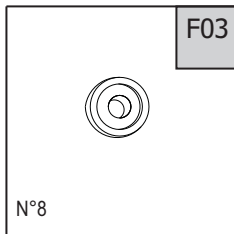
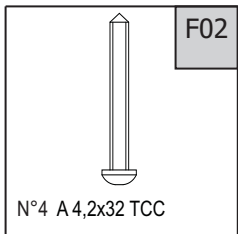
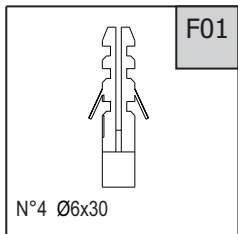
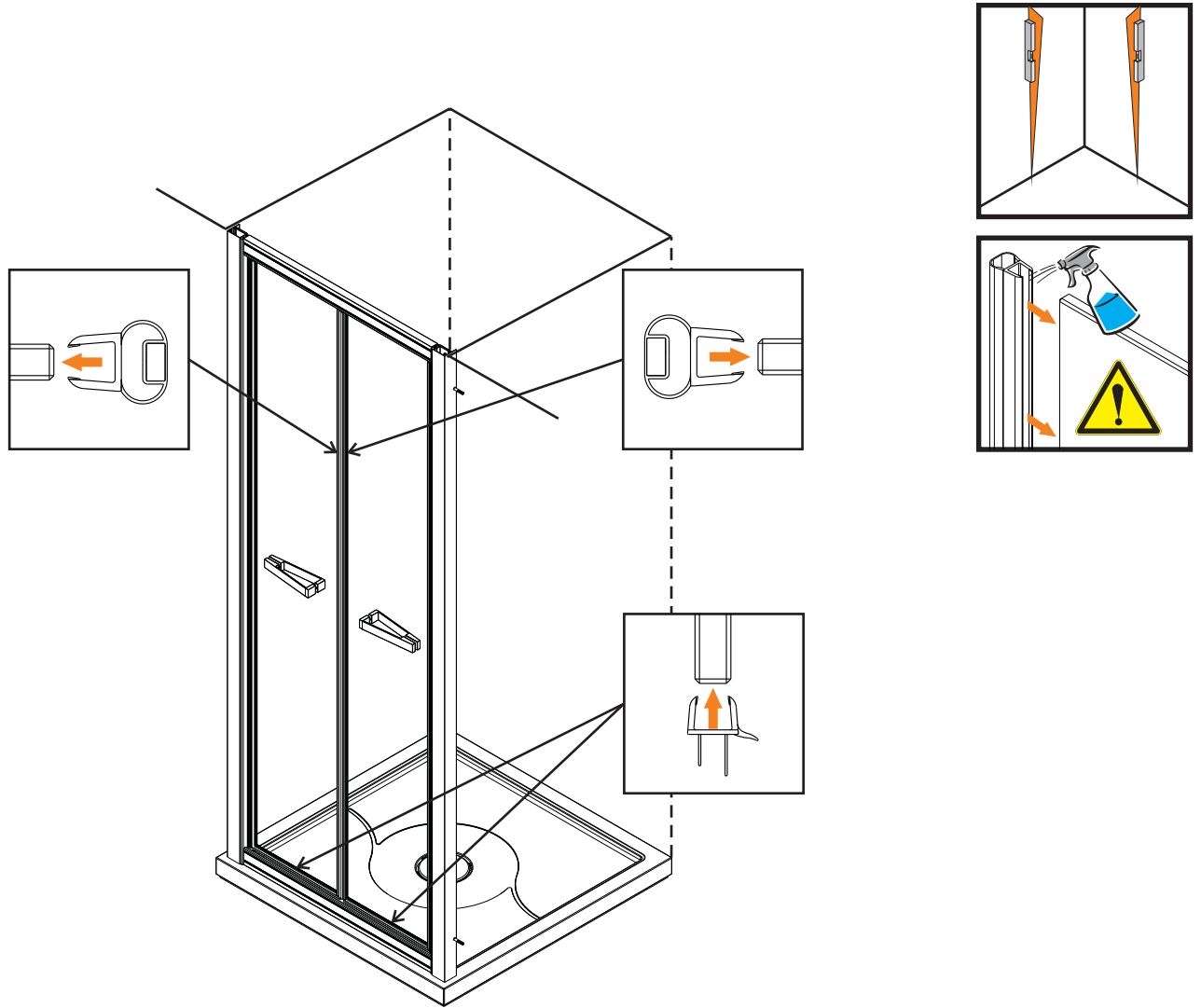

01

