

ICARO.

LAVABI IN CERAMICA CERAMIC WASHBASINS

Linea di mobili dedicata esclusivamente al bagno con lavabo in ceramica dagli spessori fini, disponibile in tre misure L106/88/73, aperture con ante (tranne il 106) e cassetti con guide slow-motion.

Exclusive bathroom furniture with ceramic washbasins and elegant refineries. Available in 3 sizes: W106/88/73, opening of the shutters (except 106) and drawers with slow motion movement.

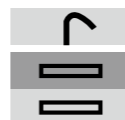



Capienti cassetti in legno alti 14 cm dotati di guide ad apertura totale e chiusura slow-motion.

Large drawers in wood with a depth of 14 cm, total opening and closure slow-motion.



Mobile sospeso con lavabo
in ceramica L73xP50xH57.
Specchio a giorno
L75xH70.
Colonna sospesa
L58xP22xH169.

Suspended cabinet
with ceramic washbasin
W73xD50xH57.
Mirror W75xH70.
Suspended long cabinet
W58xD22xH169.



Mobile sospeso con lavabo
in ceramica L73xP50xH57.
Specchio a giorno
L75xH70.
Colonna sospesa
L58xP22xH169.

Suspended cabinet
with ceramic washbasin
W73xD50xH57.
Mirror W75xH70.
Suspended long cabinet
W58xD22xH169.





**Mobile sospeso con lavabo
in ceramica L88xP50xH57.
Specchio a giorno
L60xH70.
Pensile L29xP22xH70.**

Suspended cabinet
with ceramic washbasin
W88xD50xH57.
Mirror W60xH70.
Hanging cabinet
W29xD22xH70.

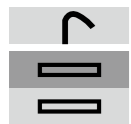

TECNICO.

Technical Specification

LAVABO / WASHBASIN ICARO.

Lavabi predisposti per il foro rubinetteria / Basins arranged for the tap hole.

Lavabi in ceramica, profondità 13 cm.

Ceramic washbasins, depth of the washbasins 13 cm.



73x50



88x50



106x50

CE EN 14688 - CL25

LAVABO / WASHBASIN ICARO SMART.

Lavabi predisposti per il foro rubinetteria / Basins arranged for the tap hole.

Lavabi in ceramica, profondità 8 cm.

Ceramic washbasins, depth of the washbasins 8 cm.



40x35



60x35



80x35

CE EN 14688 - CL20

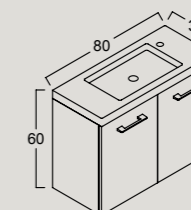
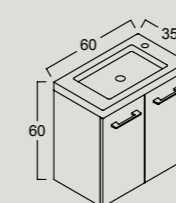
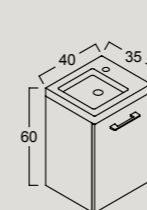
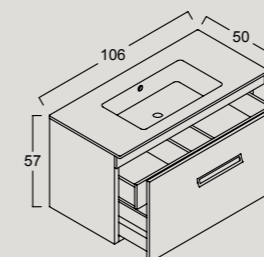
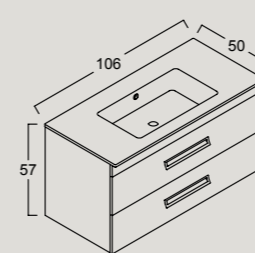
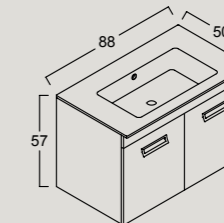
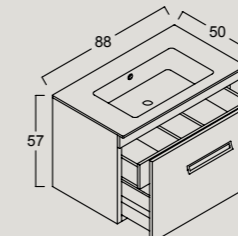
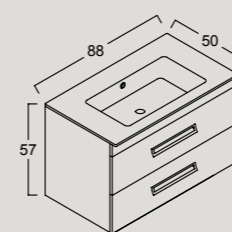
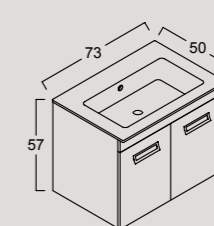
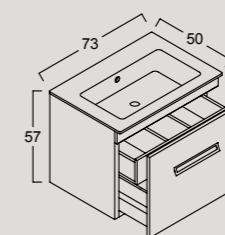
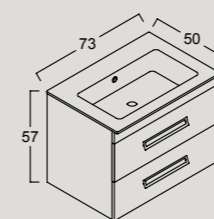

TECNICO COMPLEMENTI.

Technical Specification/Complements

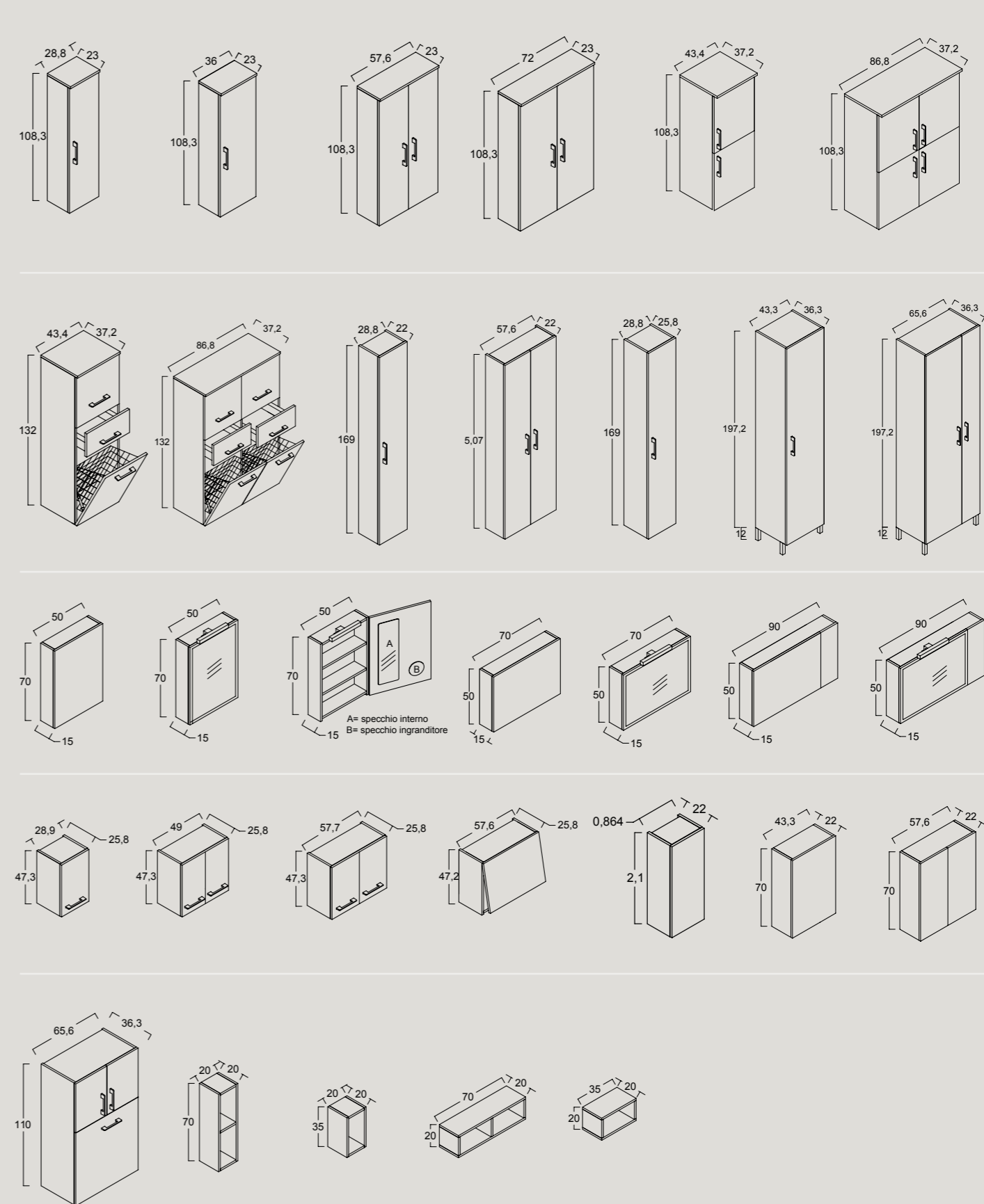
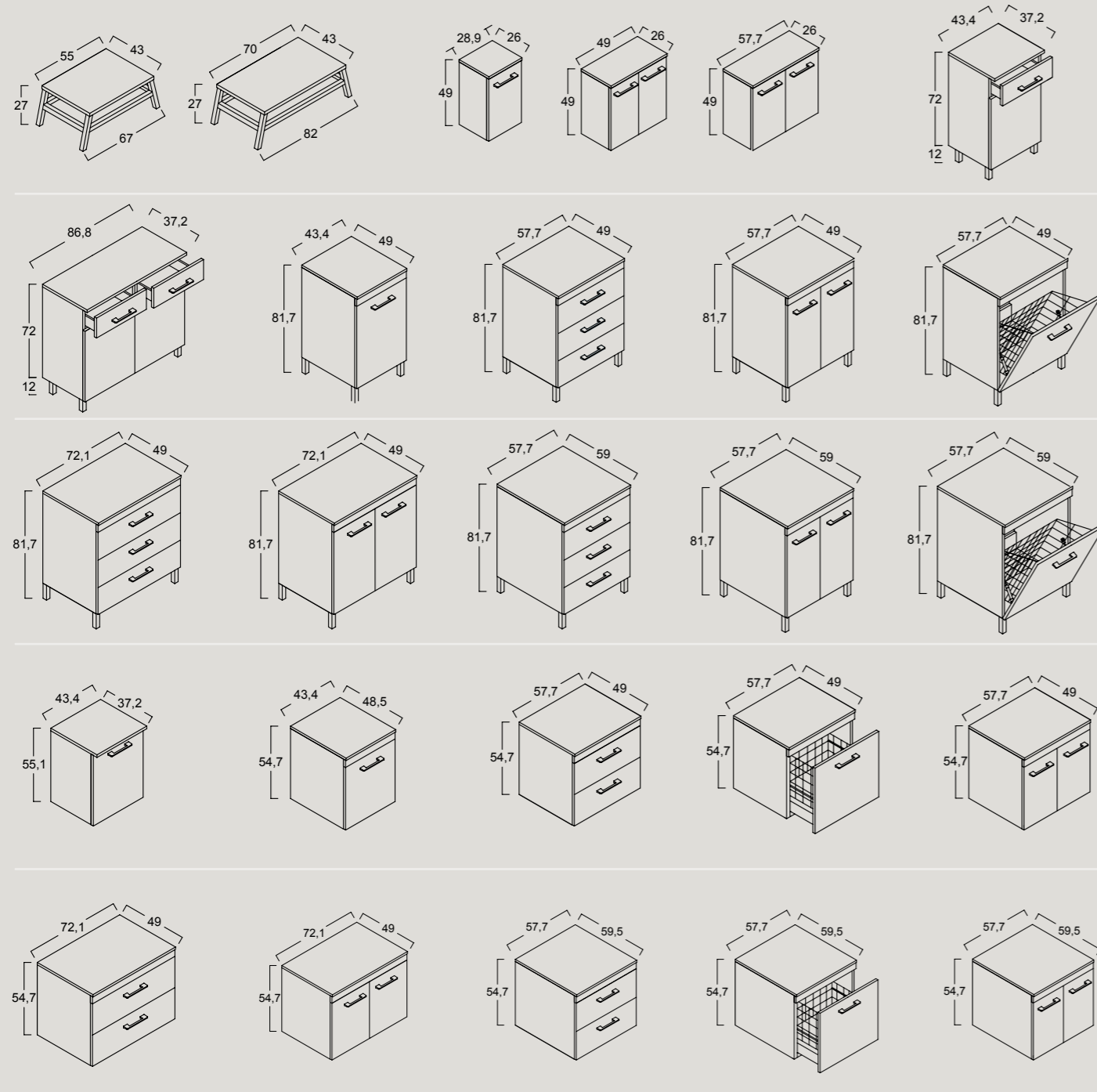

TECNICO SPECCHI E LUDOS.

Technical Specification/Mirrors and Ludos.

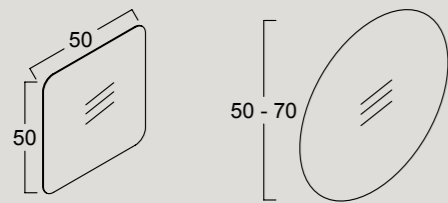
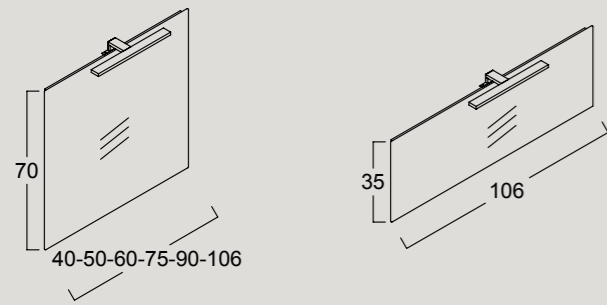

Mensole/Shelves

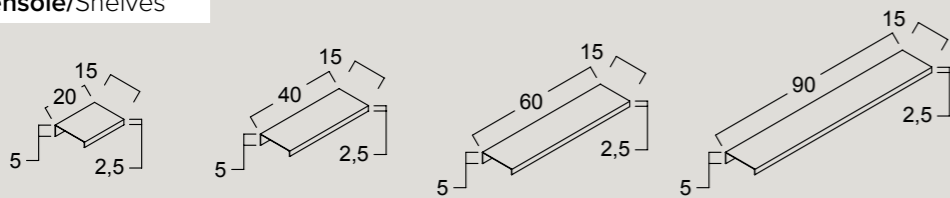

Contenitore a giorno/Open unit

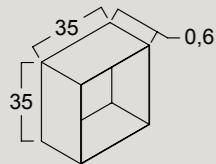

LUDOS.

TECNICO MANIGLIE E PIEDINI.

Technical Specification/Handles and legs

Belt 160

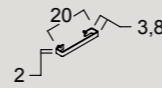

Belt 224



Belt 352



Belt 544

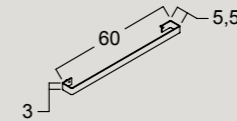

PROFILO 188

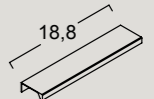

FILO 160



FILO 512

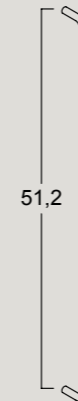

QUADRA 160

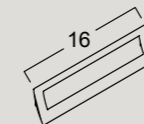

QUADRA 320

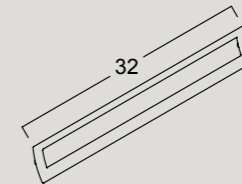

LAMA 160



RETRÒ



MARGERITA



MARGERITA FLEURS

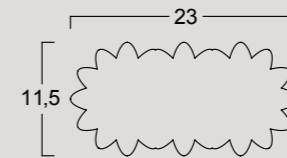

MARGERITA BOUQUET

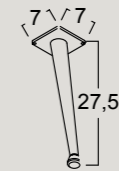
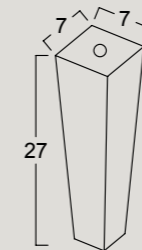
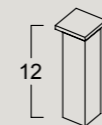
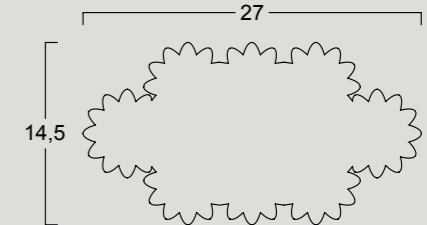

TECNICO LAMPADE.

Technical Specification/Lamps

ALOGENA

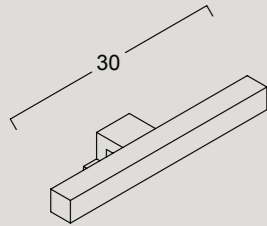

SFERA

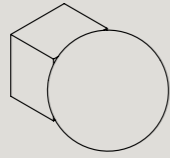

LUNA 30

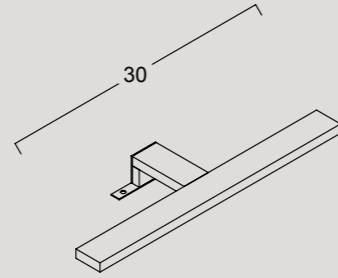

LUNA 50

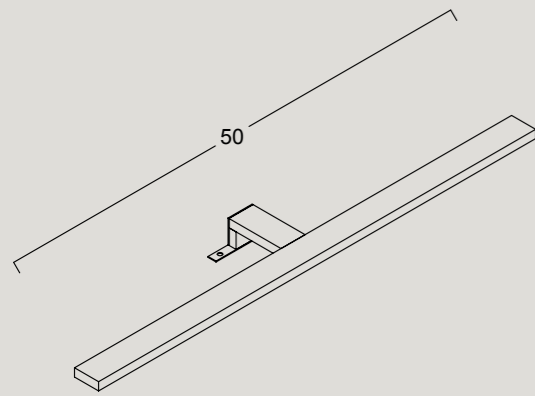

QUAD

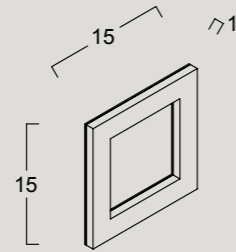

SPLINE



RETTANGOLO

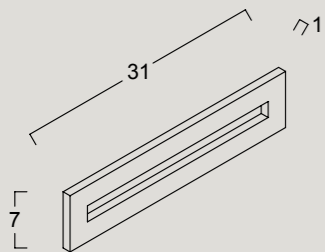

POWER BOX

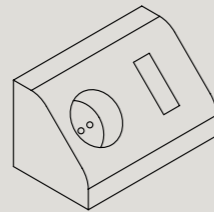

TECNICO ACCESSORI.

Technical Specification/Accessories

