



FORMATO / Format : 52x52

FORMATO / Format : 40x80

NERO
GRIGIO
CENERE
NOCE
SABBIA

FORMATO ESAGONALE / Hexagon

DOMUS



Domus Cenere 52x52

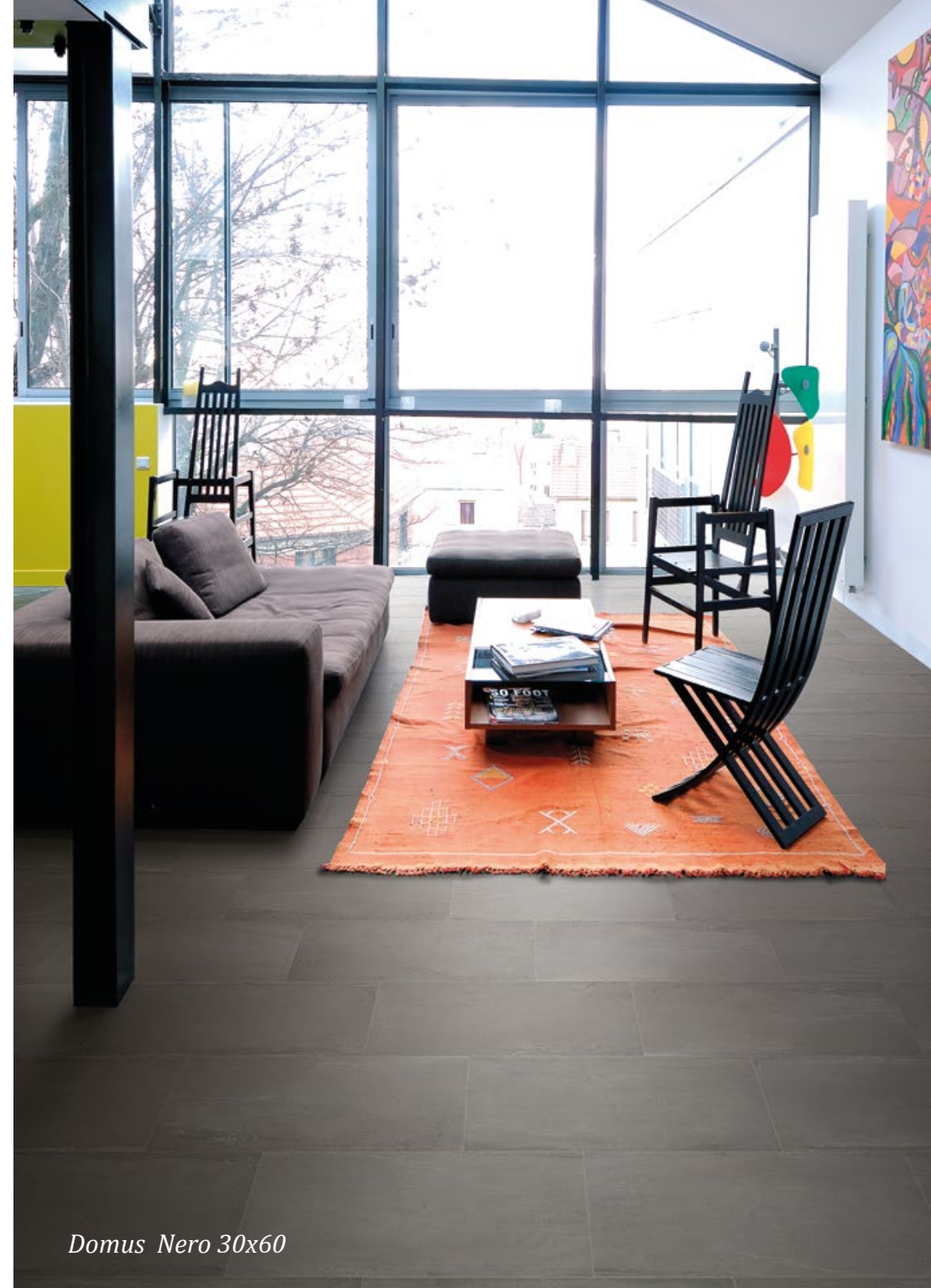

Domus Nero 30x60

COLORE / *Color* : NERO

COLORE / *Color* : GRIGIO

COLORE / *Color* : NOCE

COLORE / *Color* : CENERE

*GRIGIO FREDDO

*GRIGIO CALDO

COLORE / Color : SABBIA

COLORE / Color :
SABBIA - NERO

DOMUS ^{V3} 3D

COLORE / Color : SABBIA

IMPASTO COLORATO
colored body

80 cm

40 cm



COD. SR80130 Sabbia Rettificato

PEI
V

52 cm

52 cm



COD. S52130 Sabbia

PEI
V

30 cm

60 cm



COD. S9130 Sabbia

PEI
IV

IMPASTO COLORATO
colored body



PEI
V

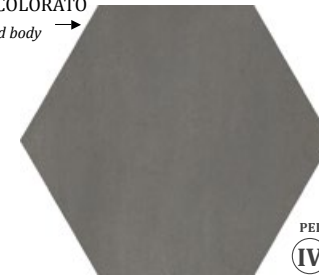

PEI
IV

COD. S40130ESA Sabbia

94

COD. S40139ESA Nero

94

COD. S40130ESAA Sabbia Antislip R11

98

COD. S40139ESAA Nero Antislip R11

98

IMPASTO COLORATO
colored body

80 cm

40 cm



COD. SR80139 Nero Rettificato

PEI
IV

52 cm

52 cm



COD. S52139 Nero

PEI
IV

30 cm

60 cm



COD. S9139 Nero

PEI
III

COLORE / Color : NERO

NUOVO FORMATO / New Size
ESAGONO / Hexagon

DOMUS ^{V3} 3D

COLORE / Color : NOCE



COD. SR80138 Noce Rettificato

94

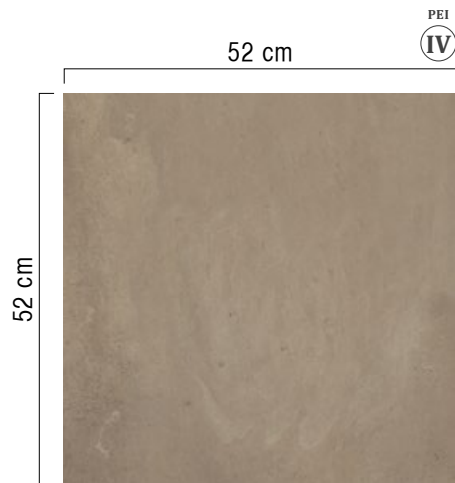

COD. S52138 Noce

38

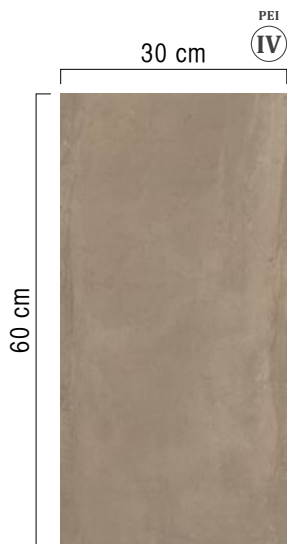

COD. S9138 Noce

38



COD. S40138ESA Noce

94

COD. S40137ESA Cenere

94

COD. S40138ESAA Noce Antislip R11

98

COD. S40137ESAA Cenere Antislip R11

98

COLORE / Color : CENERE



COD. SR80137 Cenere Rettificato

94

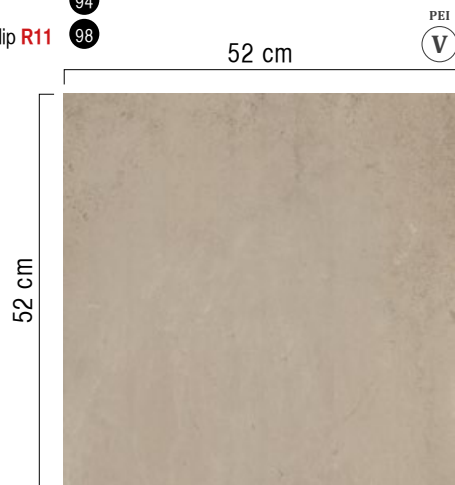

COD. S52137 Cenere

38



COD. S9137 Cenere

38

DOMUS ^{V3} 3D

COLORE / Color : GRIGIO



COD. SR80133 Grigio Rettificato

94



COD. S52133 Grigio

38



COD. S9133 Grigio

38



COD. S40133ESA Grigio

94

COD. S40133ESAA Grigio Antislip R11

98

CONSIGLIO DI POSA:
BIANCO - NERO

Suggested laying

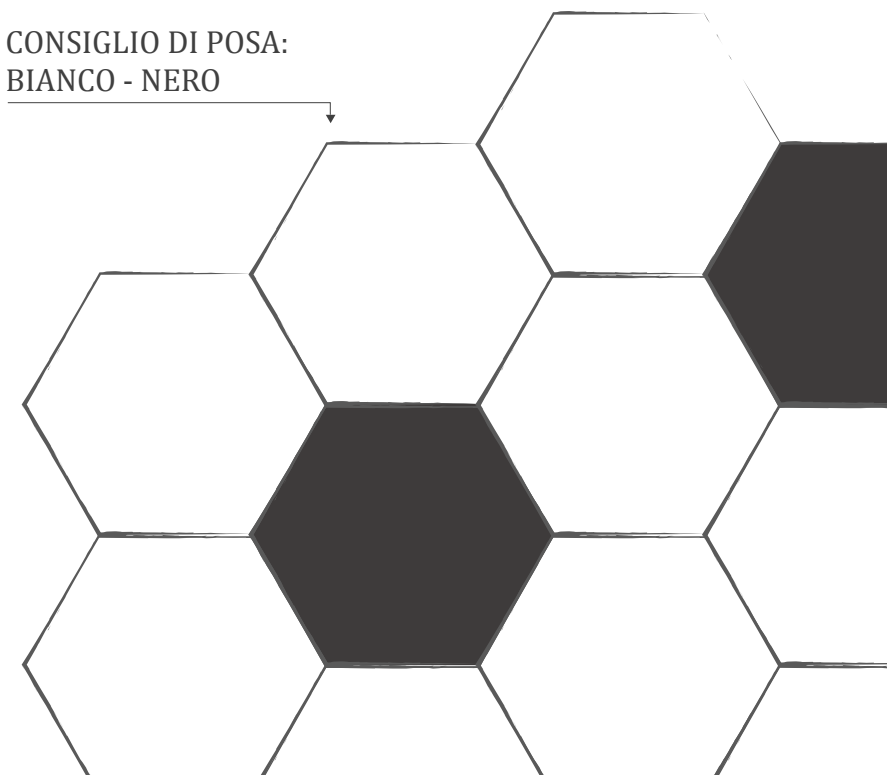



Domus Pavimento Noce 40x80
Domus Rivestimento Esagono Bianco/Noce



Domus Pavimento Esagono Cenere
Domus Rivestimento Noce 40x80

PEZZI SPECIALI / Trim Pieces

BATTISCOPA: SBT + COD.

- 10x80 **17**
- 10x60 **88**
- 8,6x52 **11**

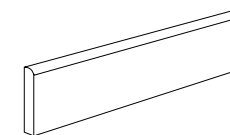

Hexagon

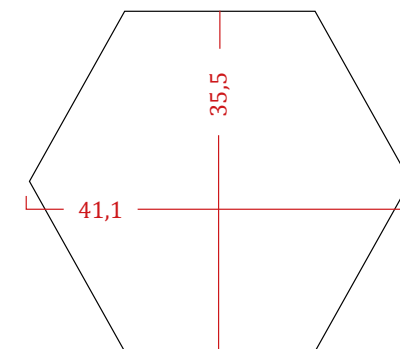

DCOF: 40x80 = 0,66

IMBALLI / Packaging

scatola / boxes / kartons / boites	F.to	Pz	m ²	Kg
40x80	3	0,96	22,50	
52x52	4	1,08	22,50	
30x60	7	1,26	26,1	
HEXAGON 40x40	9	0,93	21,50	

palette / pallets / paletts / pallet	F.to	Pz	m ²	Kg
40x80	60	57,6	1.370	
52x52	36	38,9	830	
30x60	40	50,4	1.064	
HEXAGON 40x40	9	44,9	1.052	



SAVOIA ITALIA S.p.A

Via Ghiarola Nuova 77

TEL. +39 0536 838411

FAX ITA. +39 0536 838461 FAX ESTERO +39 0536 832427

info@savoiaitalia.it - www.savoiaitalia.it